

## Datasheet - BPS 250

Safety sensors / BNS 250 / Actuator



- thermoplastic enclosure

(Minor differences between the printed image and the original product may exist!)

### Ordering details

Product type description	BPS 250
Article number	1120594
EAN code	4030661049168

### Global Properties

Product name	Magnet
Materials	
- Material of the housings	Plastic
Weight	15 g

### Dimensions

Dimensions of the actuators	
- Width of the actuator	33 mm
- Height of the actuator	25 mm
- Length of the actuator	13 mm

### Included in delivery

tamperproof screws	2 piece
--------------------	---------

### Images

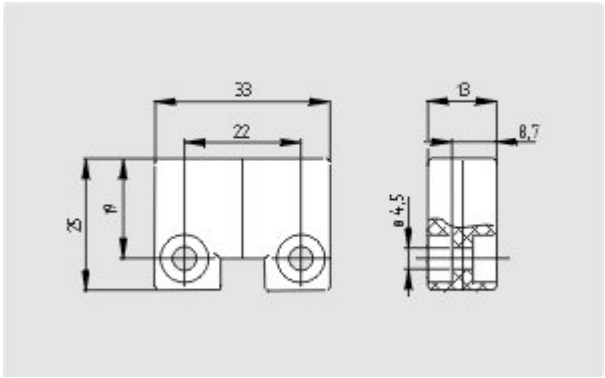

Dimensional drawing (miscellaneous)

---

K.A. Schmersal GmbH, Möddinghofe 30, D-42279 Wuppertal  
The data and values have been checked thoroughly. Technical modifications and errors excepted.  
Generiert am 29.03.2010 - 17:13:11h Kasbase 1.3.5 DBI